

# MorphoAccess® SIGMA Lite Series

## Quick User Guide

2015\_2000005700-V4



**MorphoAccess® SIGMA Lite+**



**MorphoAccess® SIGMA Lite**

*All descriptions, illustrations, and specifications in this brochure should be considered approximate and may relate to optional equipment or feature*

*This document and the information therein are the property of Morpho, and must not be copied or communicated to a third party without the prior written authorization of Morpho.*

# Table of Contents

Color	Step	Content
	One	Overview
	Two	Wiring
	Three	Communication
	Four	ACP or SDAC
	Five	Administration
	Six	Software
	Seven	Enrollment
	Eight	Optional features

# Product Overview

The MorphoAccess® SIGMA Lite Series terminal has a simple and ergonomic man-machine interface designed for access control and Time & Attendance, with fingerprint recognition, contactless card authentication and PIN authentication options.

Embedded web server  
(configuration & enrolment)

## Terminal designation

MorphoAccess® SIGMA	Lite+	(none)
		ICLASS
Lite		MULTI
		PROX

HID® iCLASS™ 13,56MHz (SIGMA ... ICLASS)  
Or MIFARE™ DESFire™ 13,56MHz (SIGMA .. MULTI)  
Or HID® Prox® 125kHz (SIGMA .. PROX)

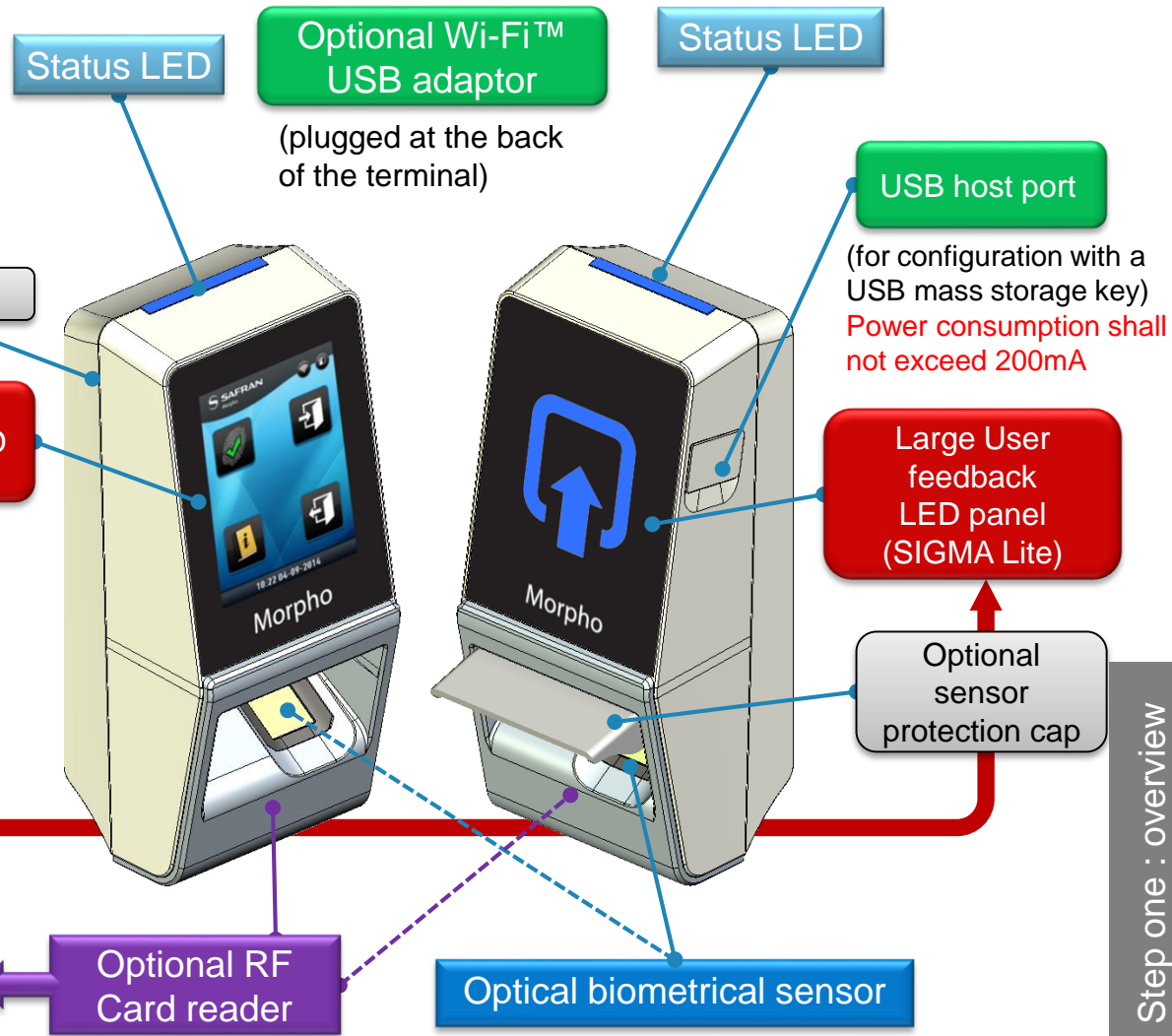

Step one : overview

# MorphoAccess® SIGMA Lite Checklist

## Product packaging checklist:

QTY	ITEM
1	MorphoAccess® SIGMA Lite or Lite+ terminal
1	Back door equipped with cables and screws
1	Protection Accessory (optional)
1	Wall Mounting Plate
1	Documentation package



Lite



Lite+

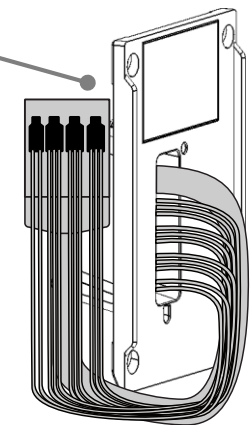
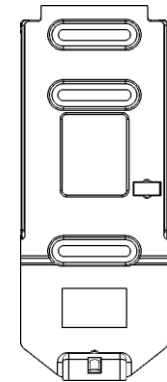

Step one : overview

Electronic documentation is provided in Adobe® Acrobat® format (PDF). Adobe® Acrobat® Reader is available at <http://www.adobe.com>.

# MorphoAccess® SIGMA Lite terminal Implementation

To secure an access, Morpho recommends installing the MorphoAccess® SIGMA Lite Series terminal as a part of a typical Access Control system, which consists of the components described below.

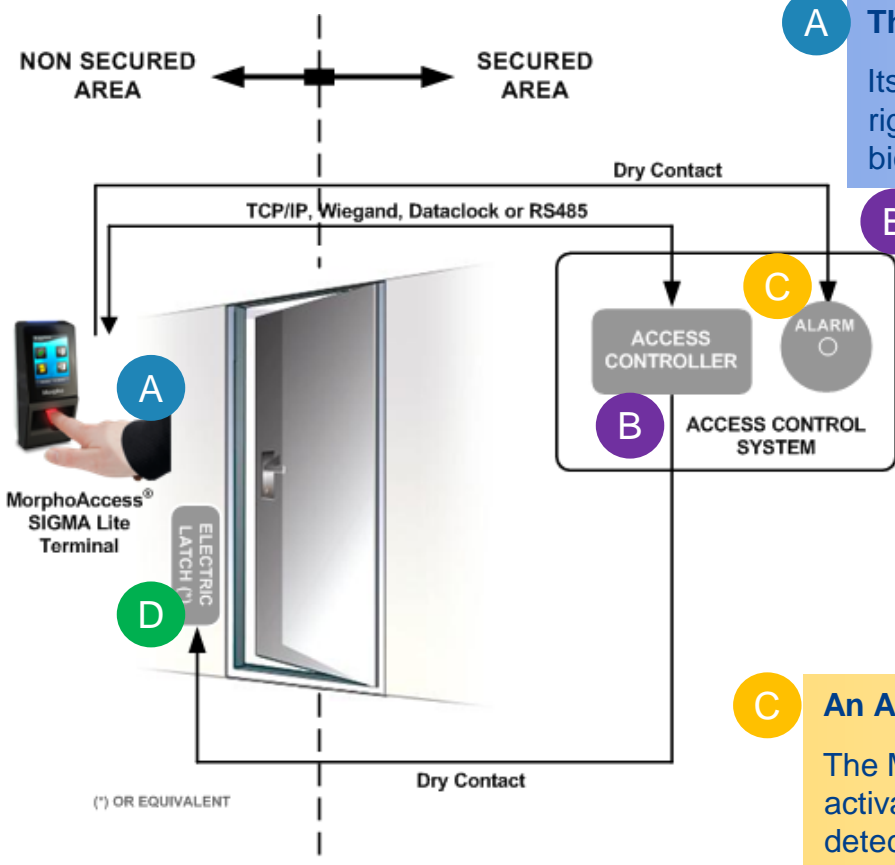

**A The MorphoAccess® SIGMA Lite Series terminal**  
Its role is to process the access request from the user. It performs access right checks using one-to-many biometric identification or one-to-one biometric verification, and/or RF card authentication, and/or PIN check.

**B An Access Controller (3rd party product)**  
The MorphoAccess® terminal interfaces with an Access Controller (using TCP/IP, Wiegand, Data Clock or RS485 protocol):

- ➔ After access request, the MorphoAccess® terminal sends the result of user's access rights to the Access Controller (this message contains at least the User ID)
- ➔ The Access Controller performs additional checks, and returns the final decision (access granted/denied) to the MorphoAccess® terminal (which displays the result to the user), and to the door controller which opens the door (if the access has been granted).

**C An Alarm (3rd party product)**  
The MorphoAccess® terminal sends a message to the Access Controller, to activate the Alarm as soon as a malicious activity, such as tamper or pulling, is detected

**D A Door Electric Latch or equivalent (3rd party product)**  
The Access Controller sends a command to activate the latch if the access is granted (i.e. if the individual's User ID is listed in the Controller authorized user List). Control of the latch is made through a dry contact..

Step one : overview

# Typical Access Control Process



On Access Request, the terminal checks user's access rights using a biometric check.

If the result of the check is successful (user recognized), a message is sent to the Central Access Controller for additional access rights check.

If the user is allowed to access to the protected zone, the central access controller returns an "access granted" message to the terminal and a "open" command to the gate controller.



User's fingerprints must be stored in the terminal database or in contactless card, to enable biometric check.

# MorphoAccess® SIGMA Lite Access Control Modes

The terminal can be configured in one of the modes described in the table below

	Identification	Authentication	Multifactor	Proxy
Access control application	Application that runs on the terminal when it starts.	Application that runs on the terminal when it starts.	Application that runs on the terminal when it starts.	Remote application that controls the terminal through network commands
Access control triggering event	A user places a finger on the biometric sensor.	A user places a contactless card in front of the reader. (*)	Both Identification and Authentication triggers are enabled.	Triggering events are selected by the remote application
Biometric check (if enabled)	The user's captured fingerprint is matched against all fingerprints in the terminal database.	The user's captured fingerprint is matched against their reference fingerprint. (**)	As per Identification or Authentication, depending on the triggering event	Selected by the remote application
Decision to display result signal to user	By Identification standalone application	By Authentication standalone application	By running standalone application	By remote application

(\*) or the user enter their Identifier on the keypad, or a Wiegand frame is received from an external device

(\*\*) stored on the contactless card or in the user record in the terminal's local database

# Deployment Environments

Operating temperature	-10° to + 55 ° C (14° to 131° F)
Operating humidity	10 % < RH < 80 % (non condensing)
Storage temperature	-25° to + 70 ° C (-13° to 158° F)
Storage humidity	5% < RH < 95 %
IP code	IP65 rated, once backdoor fixed with the 4 screws

## General precautions

- Do not expose the terminal to extreme temperatures.
- When the environment is very dry, avoid synthetic carpeting near the MorphoAccess® SIGMA Lite terminal, to reduce the risk of unwanted electrostatic discharge.

## Areas containing combustibles

- Do not install the terminal in the vicinity of gas stations or any other installation containing flammable or combustible gases or materials. The terminal is not designed to be intrinsically safe.

## The terminal should be installed in controlled lighting conditions

- Avoid biometric sensor exposure to a blinking light
- Avoid direct exposure of the biometric sensor to sunlight or to UV lights.



# Wiring Overview

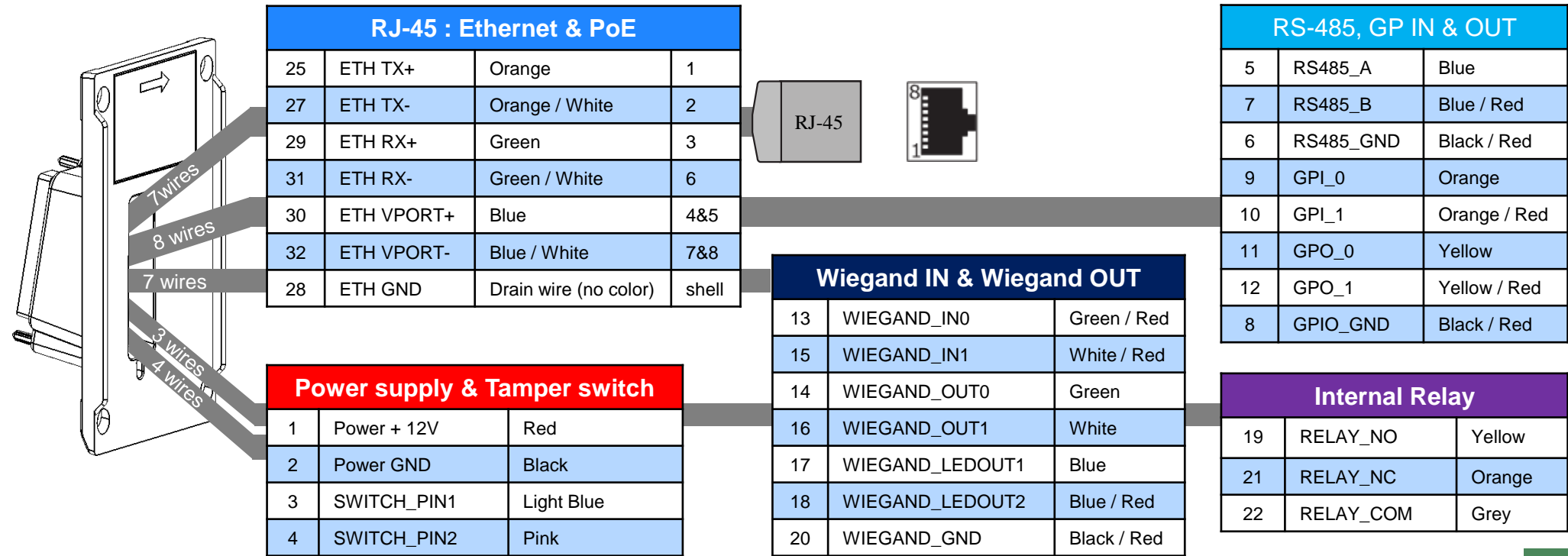

All connections of the terminal are of SELV (Safety Electrical Low Voltage) type.

**Power supply from electrical source shall be switched off before starting the installation.**

**Before proceeding, make sure that the person in charge of installation and connections, is properly connected to earth, in order to prevent Electrostatic Discharges (ESD).**

**Backup of the Date/Time of the terminal:** the volatile settings (such as date/time) of the terminal are protected against power failure, by a dedicated component during a least 24 hours (at 25°C) without external power supply.

Step two : wiring

# Power Wiring

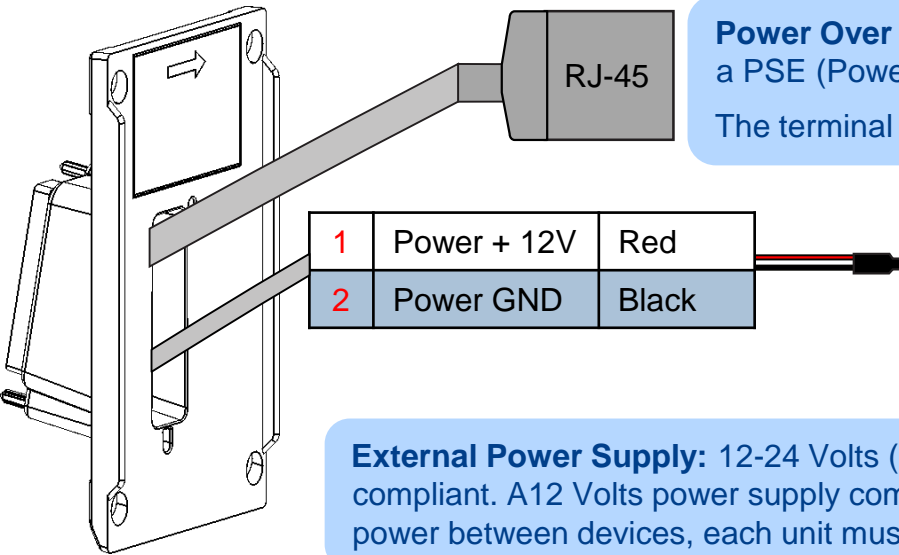

**Power Over Ethernet (POE):** power can be provided through RJ-45 connector using a PSE (Power Sourcing Equipment) **IEEE 802.3af or IEEE802.3at type 1** compliant. The terminal is a Class 0 (15.4W) PD (Powered Device).

## PoE Injector Specs

- Output Voltage: 48VDC
- Output Current: 0.32A
- Power: 15.36W

**External Power Supply:** 12-24 Volts (regulated and filtered) 1 Amp min @12V, CEE/EEC EN60950 standard compliant. A12 Volts power supply compliant with SIA's Wiegand standard will also be suitable. If sharing power between devices, each unit must receive 1A (e.g. two units would require a 12VDC, 2A supply).

*A battery backup or uninterruptured power supply (UPS) with built-in surge protection is recommended.*

Morpho recommends using a gauge AWG20 for 12V power supply.

The voltage measured on the product block connector of the terminal must be equal to 12V-24V (-15% / +10%).

The table at the right, shows the maximum voltage drop between the power source and the terminal, depending on the length of the cable.

Gauge AWG	Diameter (mm)	Maximum drop voltage (V)		
		at 1m	at 5m	at 10m
20	0.81	0.03	0.17	0.33
22	0.64	0.05	0.26	0.53
24	0.51	0.08	0.42	0.84



**WARNING: Under powering may cause memory and data corruption; over powering may cause hardware damage. Both of these situations will void the warranty**

# RS-485 Communication

## Wiring Block

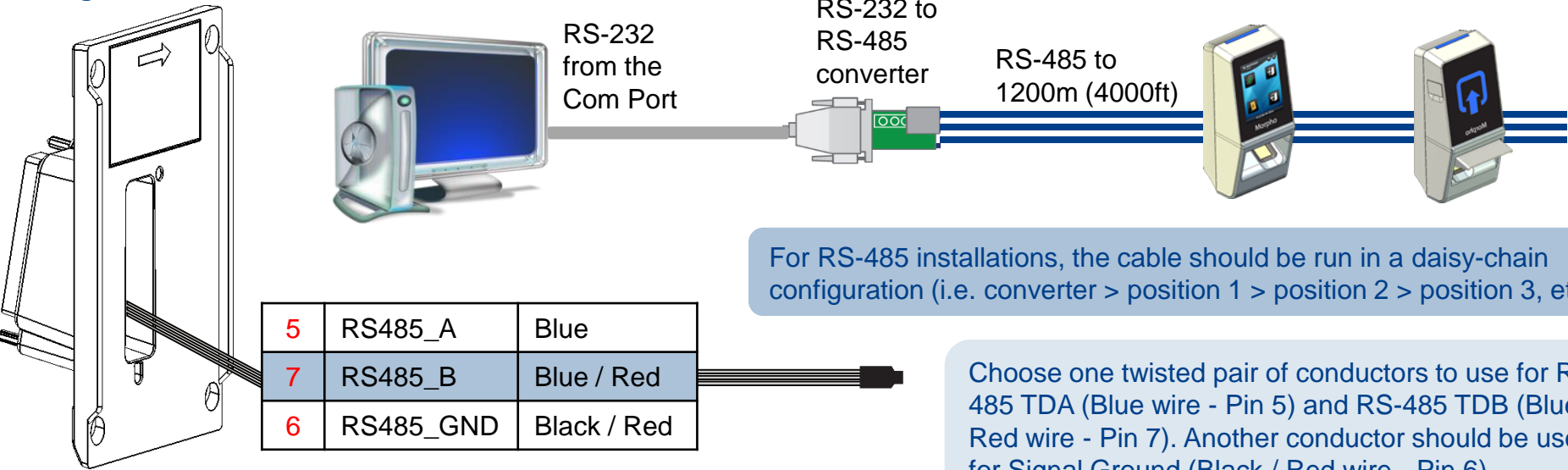

For RS-485 installations, the cable should be run in a daisy-chain configuration (i.e. converter > position 1 > position 2 > position 3, etc.).

Choose one twisted pair of conductors to use for RS-485 TDA (Blue wire - Pin 5) and RS-485 TDB (Blue / Red wire - Pin 7). Another conductor should be used for Signal Ground (Black / Red wire - Pin 6).

Use CAT-5 UTP (or better) cable (shielded recommended) with a characteristic impedance of 120 ohms. AWG 24 should be the minimum wire gauge used.

Choose a RS-232 to RS-485 converter that supports Sense Data to switch from Send to Receive mode.

**IMPORTANT:**

- > A maximum of 31 devices may be installed on the same line.
- > The maximum total cable length is 4000 ft. (1200m).
- > The cable must be dedicated to this installation and not used for any other purpose



Step three : communications

# Ethernet and Wireless LAN

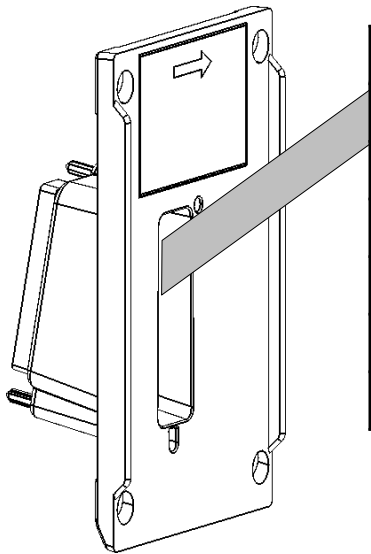

25	ETH TX+	Orange	1
27	ETH TX-	Orange / White	2
29	ETH RX+	Green	3
31	ETH RX-	Green / White	6
30	ETH VPORT+	Blue	4 & 5
32	ETH VPORT-	Blue / White	7 & 8
28	ETH GND	Drain wire (no color)	Shell

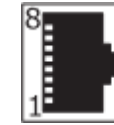
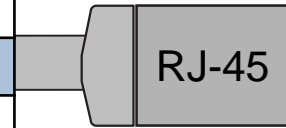

Use a category 5 shielding cable (120 Ohms) or better. It is strongly recommended to insert a repeater unit every 90m.

DHCP is enabled by default on MorphoAccess® SIGMA Lite terminals (factory setting).

## Terminal Block Ethernet connection

- ➔ Extreme care must be taken while connecting Ethernet wire to the block board since low quality connection may strongly impact Ethernet signal sensibility.
- ➔ Connect Rx+ and Rx- with the same twisted-pair wire (and to do the same with Tx+/Tx- and the other twisted-pair wire).

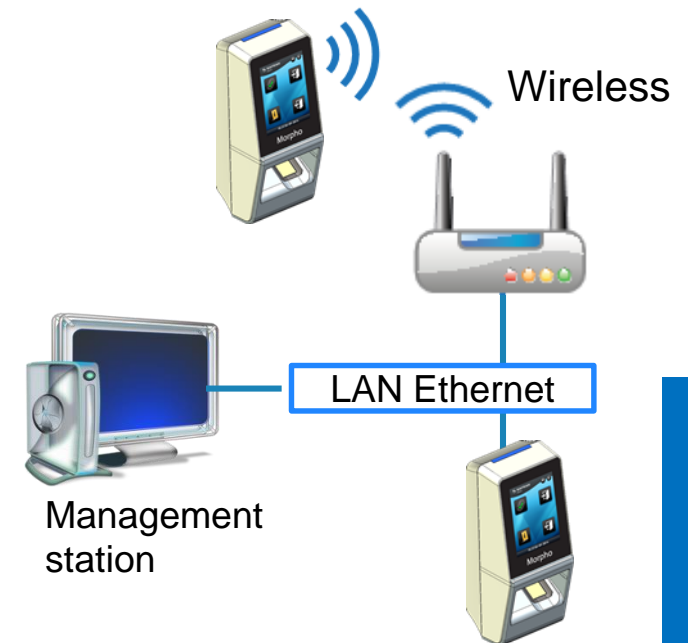

## WLAN option

Morpho wireless enabled devices support 802.11b and 802.11g standards. WEP Open, WPA and WPA2 are supported.

# Wiegand Communication

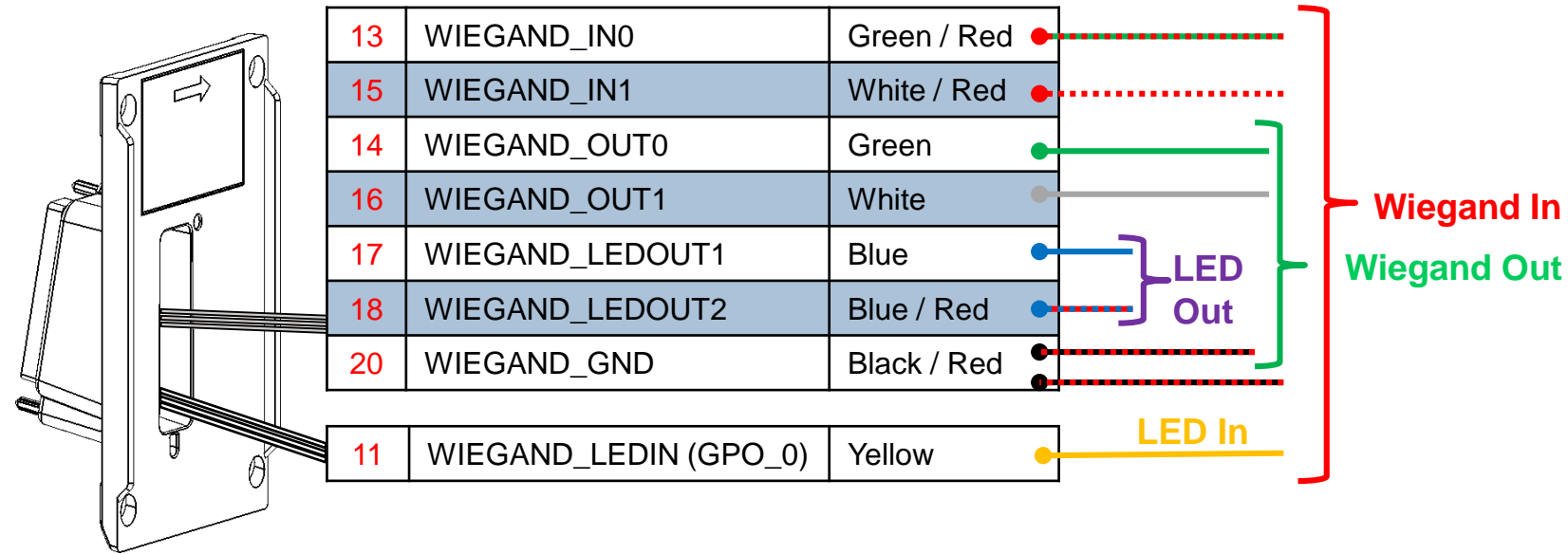

Three-conductor wire (shielded recommended) is required for Data 0, Data 1, and WGND.

Use 18-22 AWG cable in a homerun configuration from each unit to the Access Control Panel (ACP).

- Connect **WIEGAND\_OUT0** (Green wire – Pin 14) to ACP Data 0,
- Connect **WIEGAND\_OUT1** (White wire – Pin 16) to ACP Data 1,
- Connect **WIEGAND\_GND** (Black / Red wire – Pin 20) to ACP reader common (0vDC).

For 18 AWG, the maximum cable distance is 500 ft. (150m); for 20 AWG, the maximum is 300 ft. (90m); for 22 AWG, the maximum is 200 ft. (60m).

All controller output shall be open drain or 5V+/-5%

# Wiegand Communication (continued)

## Important

By default, the Wiegand output format is not enabled. Wiegand output must be configured before connecting to the ACP.

## Note

On installation, the system administrator will be prompted to select either a pre-existing Wiegand frame format or create a custom format, and upload it to the unit before the first use.

## Data Clock

The Wiegand port also supports the Clock & Data protocol. The wiring is described below.

## Example Format Information

Type: **Standard 26-bit**

- Alt Site Code and Fail Site Code Range: **0-255**
- Template ID Number Range: **1-65535**
- Extended ID Number Range: **N/A**
- ID Start Bit: 9
- Length of ID: 16
- Site Code Start bit: 1
- Length of Site Code: 8
- Start Bit length : 0

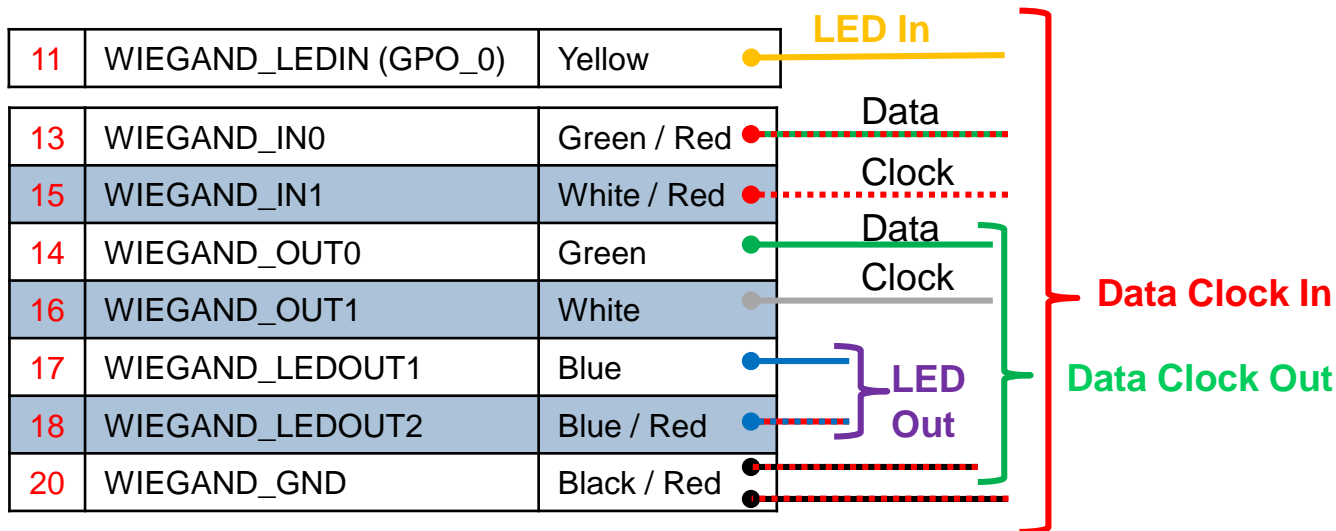

# Single Door Access Control (SDAC)

## Single Door Access Control (SDAC) wiring sample with Push Button for request to exit (REX)

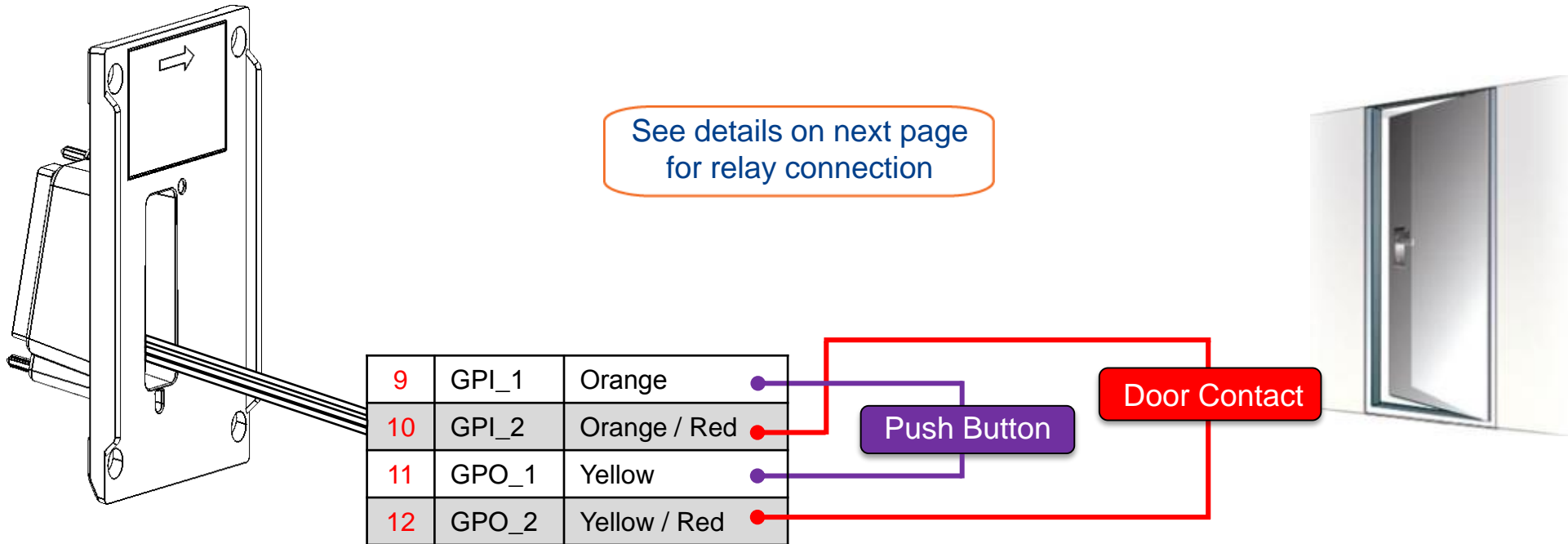

If the door contact is not used, GPI\_2 (10) and GPO\_2 (12) must be connected together.



GPI\_1 (9) and GPO\_1 (11) are the push button REX contacts. Either a N.O. or N.C. momentary push button can be used.

# Internal Relay Wiring

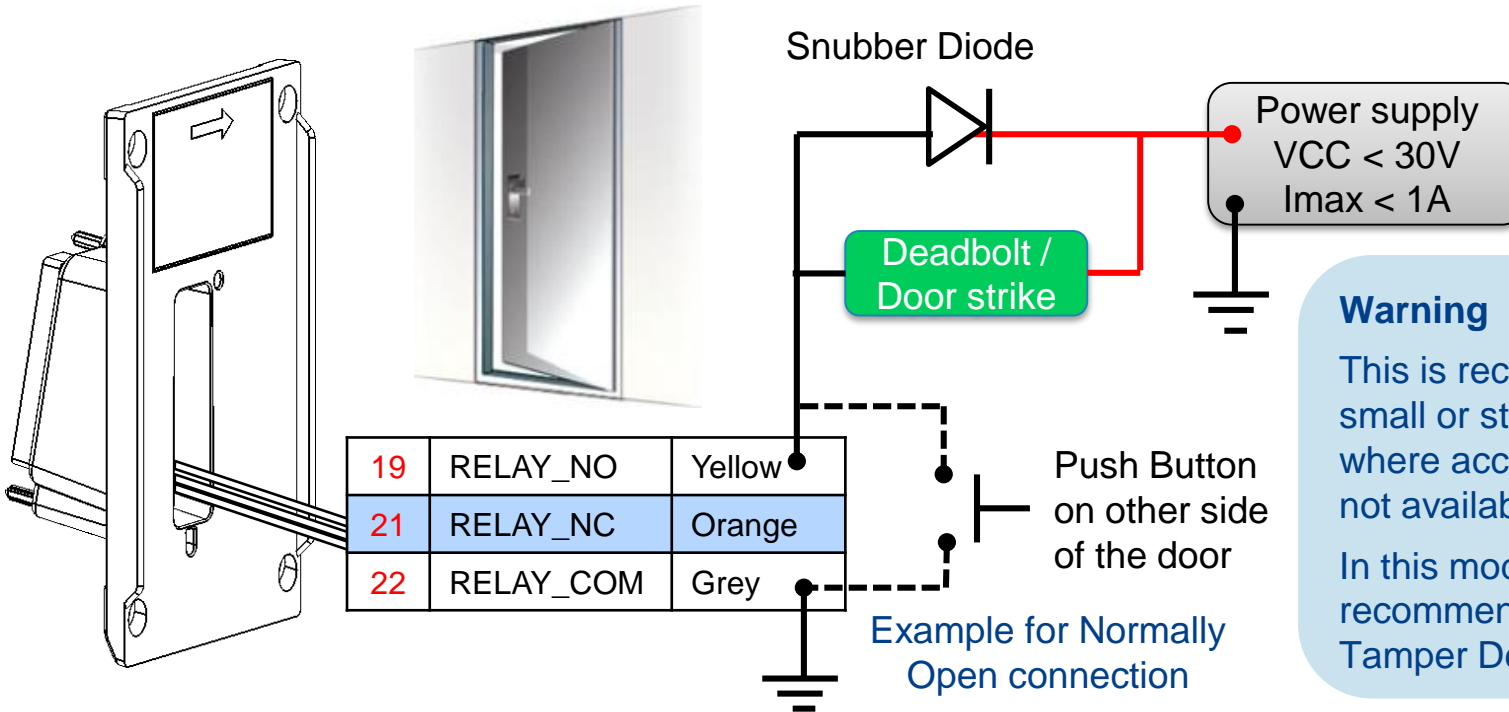

## Warning

This is recommended only for small or stand-alone applications where access control panels are not available.

In this mode it is strongly recommended to monitor the Tamper Detection of the device

Inductive load management requires a parallel diode for a better contact lifetime.

## Warning

- The internal relay is limited to a maximum current of 1A @ 30V. If the deadbolt / door strike draws more than 1A, damage to the device may occur. If the deadbolt / door strike load exceeds 1A, an external relay must be used.
- The internal relay is designed for 100.000 cycles. If more cycles are needed, an external relay driven by GPO must be used.



# First communication with terminal (1/2)

## → First configuration requires a network link

- The MorphoAccess® SIGMA Lite Series terminal is designed to be able to run in standalone mode, but at least point to point connection between PC and terminal is necessary for the first configuration. It could also be necessary for database management, terminal maintenance, ...

## → Network connection methods

- Point to point Ethernet connection
  - This method requires a static IP configuration (except if DHCP server is installed on PC)
    - Use MorphoBioToolBox to configure network parameters (see next page)
- Connection through a LAN (Local Area Network)
  - If DHCP server is available on the network, network parameters will be automatically affected to terminals (contact your network administrator).
  - If no DHCP server is available, it is necessary to configure a static IP on each terminal and PC.
    - Use MorphoBioToolBox to configure network parameters (see next page)

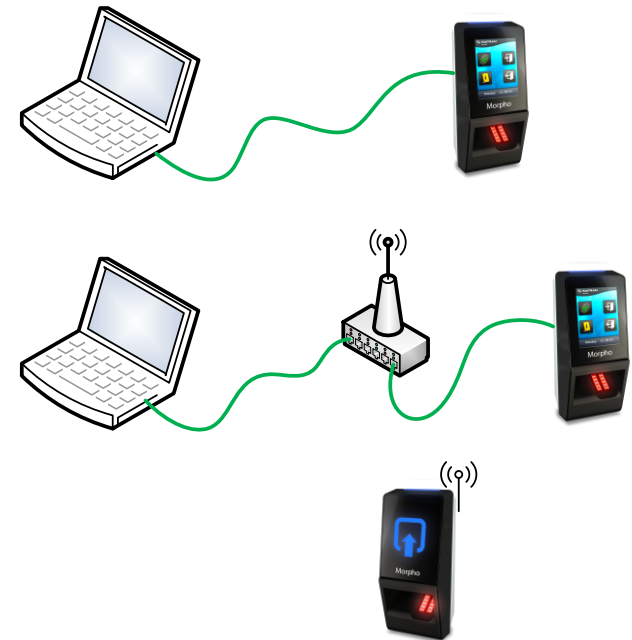

# First communication with terminal (2/2)

## → General remark for network configuration

- If terminal is connected to local network without DHCP server, be sure to configure the following parameters :
  - Administration PC and all terminals shall have a different IP address (ex : 192.168.0.1; 192.168.0.2; ...).
  - Administration PC and all terminals shall have the same network mask (ex : 255.255.255.0 if the 3 first bytes of IP address are the same for all terminals and PC).

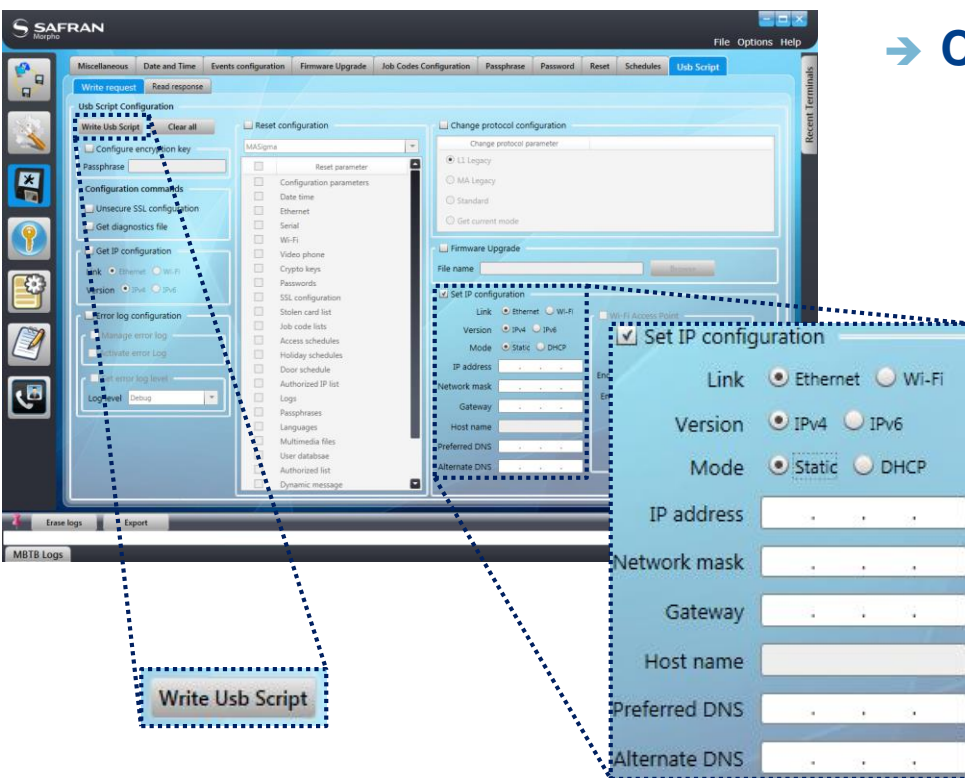

## → Configuration using MorphoBioToolbox

- Fill IP address and Network mask following previous paragraph recommendations.
- Even if not used, fill Gateway, Preferred and Alternate DNS values (using 1.1.1.1 for example).
- Click on “Write Usb Script” button and save it on USB key.
- Plug USB key to the terminal using the adaptor.
  - On Lite version, a high pitched beep, followed by purple led panel blinking and high pitched beeps and green led panel will indicate configuration is finished
  - On Lite+ version, a USB plug image followed by 2 high pitched beeps will indicate configuration is finished

# Administration with MorphoBioToolBox application

Another way to configure the MorphoAccess® SIGMA Lite Series terminal is to use a dedicated application: MorphoBioToolBox (for Windows)

Please note that this application has an embedded User Guide (Help menu).

## North and South America:

E-mail [cscenter@morpho.com](mailto:cscenter@morpho.com) with your name, phone number, serial number of your MASIGMA and **“Please Send Link for MBTB”** in the subject of your e-mail. A link to download the software will be e-mailed to you.

**Other countries:** please contact your sales representative.



### Terminal administration with MorphoBioToolBox application

The screenshot displays the MorphoBioToolBox application window. The title bar reads "SAFRAN Morpho" and "File Options Help". The main window is titled "Connection" and features a sidebar with icons for various functions. The "Terminal Type" is set to "MA Sigma". Under "Connection information", the "TCP / IP" radio button is selected. The "Address type" is set to "IP4". The "Address" field is empty, the "Port" is "11010", and the "Timeout" is "30" seconds. There are checkboxes for "Use SSL/TLS" and "Sr. No.". Below these are fields for "Terminal CA certificate path" and "Client certificate path", each with a "Browse" button. A "Client certificate password" field is also present. At the bottom, there are "Erase logs" and "Export" buttons, and a log window showing system messages.

11:34:52 - INFO - Load successful;MBTB.Plugins.RebootFeature  
11:34:52 - INFO - Load successful;MBTB.Plugins.PingFeature  
11:34:52 - INFO - Load successful;MBTB.Plugins.PasswordConfigurationTabFeature  
11:34:52 - INFO - Load successful;MBTB.Plugins.PassphraseConfigurationTabFeature  
11:34:52 - INFO - Load successful;MBTB.Plugins.JobCodesTabFeature

MBTB Logs

Step five: Administration

# Software for Terminal Remote Administration

- **MorphoAccess® SIGMA Lite Series terminals are fully compatible with:**
  - MorphoManager application(version 8.0.3 or higher)
  
- **When Legacy Morpho mode enabled, the terminal is compatible with:**
  - MEMS (version 7.3.1 or higher),
  - The limitations in Morpho Legacy mode are described in the following document:
    - MorphoAccess® SIGMA Series Release Note - Legacy Morpho limitations
  
- **When Legacy L1 mode is enabled, the terminal is compatible with:**
  - SecureAdmin (version v4.1.20.0.1 or higher),
  - The limitations in L1 Legacy mode are described in the following document:
    - MorphoAccess® SIGMA Series Release Note - Legacy L1 limitations

# Fingerprint Capture Basics 1/3



Region of Interest	Recommended Fingers	Acquisition troubleshooting
 <p>The biometric sensor is designed to capture the most useful area of the fingerprint, which is usually at the centre of the finger tip, as shown on the figure above.</p>	 <p>The sensor can capture any finger, but we recommend to :</p> <ul style="list-style-type: none"> <li>• use Fore finger / Index as 1<sup>st</sup> choice</li> <li>• use middle finger as 2<sup>nd</sup> choice</li> <li>• use ring finger as alternative 2<sup>nd</sup> choice (3<sup>rd</sup> choice)</li> <li>• avoid little finger (poor fingerprint)</li> <li>• avoid thumb (best accuracy but ergonomically more difficult to use)</li> </ul>	<p><b>General recommendations</b></p> <ul style="list-style-type: none"> <li>➤ Remove bandages or adhesive tapes from the fingerprint area</li> <li>➤ Do not press or tense finger to avoid blood vessels constriction.</li> </ul> <p><b>Fingerprint image too dark :</b> the finger is probably too moist and/or too dusty</p> <ul style="list-style-type: none"> <li>➤ <b>too moist</b> : dry the finger</li> <li>➤ <b>too dusty</b>: clean up the finger</li> </ul> <p><b>Fingerprint image too light :</b> the finger is probably too cold and/or too dry</p> <ul style="list-style-type: none"> <li>➤ <b>too cold</b> : warm up the finger</li> <li>➤ <b>too dry</b> : moisten the finger (i.e. with moistening pad) and /or warm it up.</li> </ul>

For handling large scale enrollments please contact your Morpho representative for training and services options

# Fingerprint Capture Basics 2/3



## Ideal Finger Position

### Finger Height

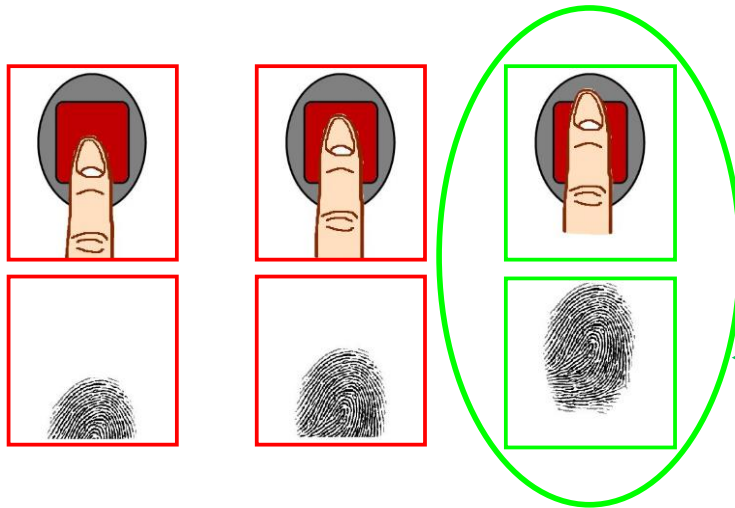

### Incorrect Position: ⚠

- Do not place the finger tip :
  - on the bottom of the sensor,
  - or in the middle of the sensor

### Correct Position:

- Align centre of finger tip with sensor centre

### Finger Angle

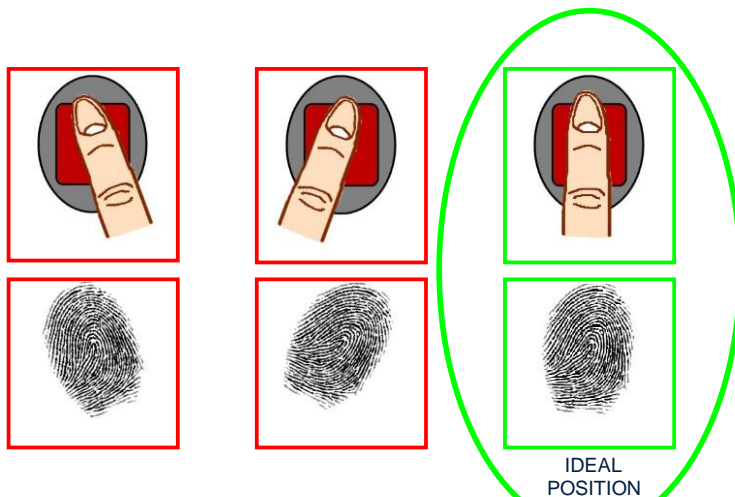

### Incorrect Position: ⚠

- Do not tilt the finger on right or left side of the sensor

### Correct Position:

- The finger must be parallel to sensor sides

# Fingerprint Capture Basics 3/3



## Ideal Finger Position

### Finger Inclination

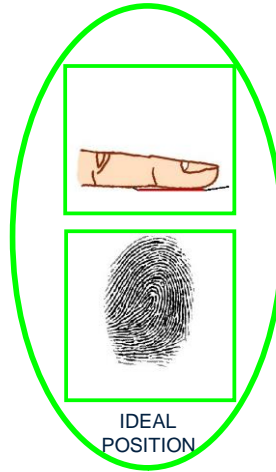
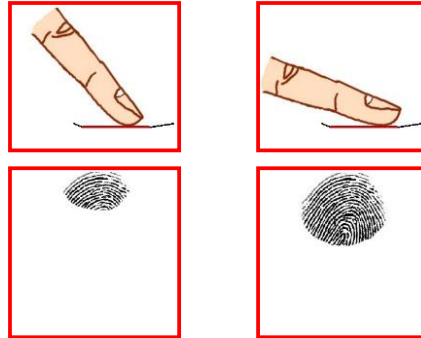

### Incorrect Position: ⚠️

- Do not leave the finger in the air
- Do not bend finger upward or downward

### Correct Position:

- Finger is parallel to sensor surface

### Finger rotation

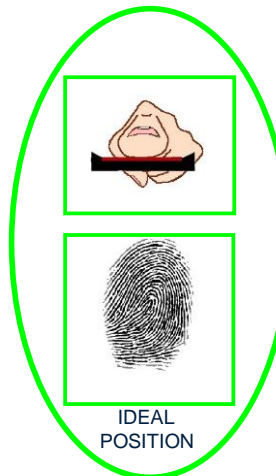
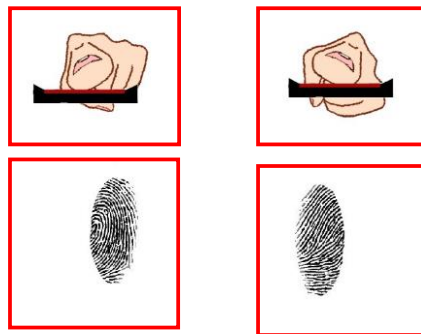

### Incorrect Position: ⚠️

- Do not roll finger

### Correct Position:

- Finger is parallel to surface sensor

# MorphoAccess® SIGMA Lite Series basic MMI



Step seven: capture basics



# MorphoAccess® SIGMA Lite+ Series basic MMI



Waiting for card

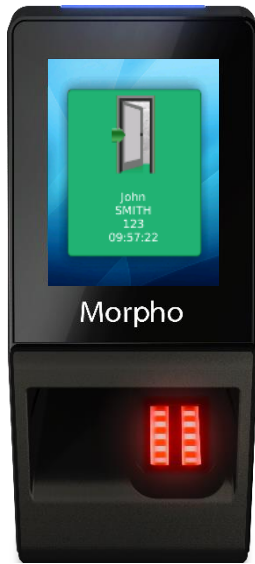

Access granted

USB script finished

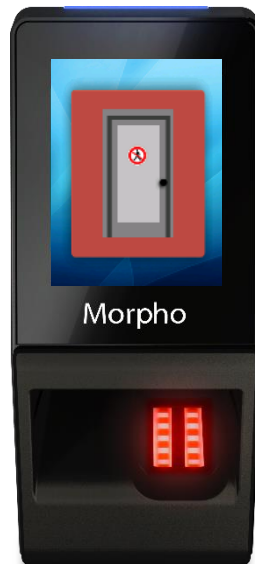

Access denied

USB script failed

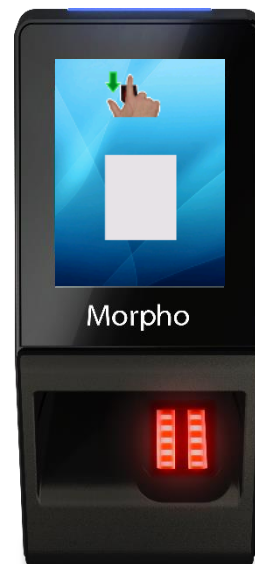

Place finger

Move finger

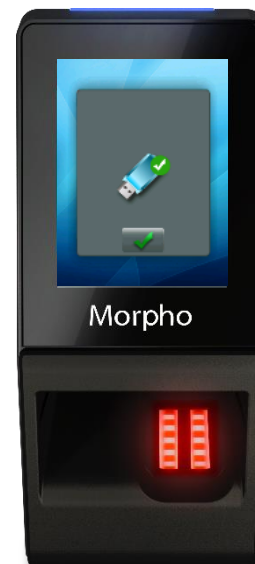

USB key detected



USB key removed

Step seven: capture basics

# Contactless Card Position – PIN Input

## Contactless Card Position



Place RF card in front of contactless card reader

Authentication of the user is initiated by the detection of a user card by the (optional) contactless card reader.

The terminal reads the user data stored in the card (at least the User ID), and starts authentication process, as required by terminal settings

## Input PIN (MorphoAccess® SIGMA Lite+)



When defined by terminal settings, the user is required to enter his PIN code, once during enrolment process, and at each authentication (in addition or instead of biometric check).

The PIN code is entered using a numeric keypad displayed on the (optional) LCD touch screen.

# Contactless Card Position – Warning



Step seven: capture basics

# Time and Attendance feature (MorphoAccess® SIGMA Lite+)

MorphoAccess® SIGMA Lite+ Series terminals support an optional Time and Attendance (T&A) feature.

For this the terminal add a specific T&A information to each identification or authentication record stored in the embedded event log database.

This information is provided by the user through a specific screen displayed during identification or authentication process.

The new screen contains 2 dedicated function keys :

- One to specify an entry or a beginning of a task
- Another key to specify an exit or an ending of a task

The user is expected to press one of the keys to provide the specific Time & Attendance information to the terminal.

Depending on terminal settings, this screen is displayed before or after the user place his finger on the sensor or his card in front of the reader

This feature is available only with the optional touchscreen LCD.

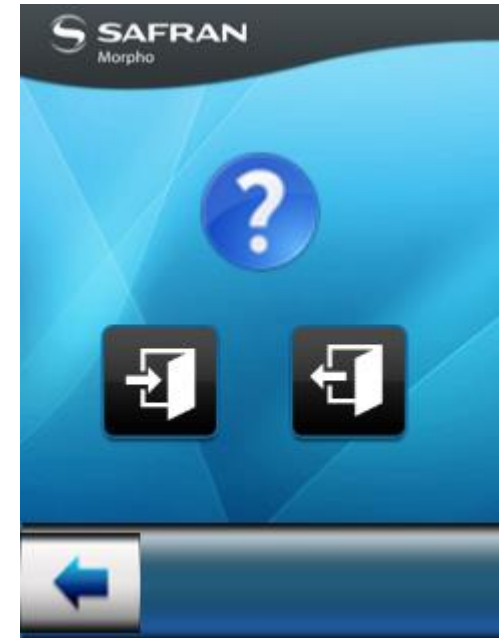

Basic Mode (screen sample)

# Recommendations

## Global warning

- The manufacturer cannot be held responsible in case of non-compliance with the following recommendations or incorrect use of the terminal.

## General precautions

- Do not attempt to repair the MorphoAccess® SIGMA Lite Series terminal yourself. The manufacturer cannot be held responsible for any damage/accident that may result from attempts to repair components. Any work carried out by non-authorized personnel will void your warranty.
- Only use the terminal with its original accessories. Attempts to use unapproved accessories with your terminal will void your warranty.

## Terminals not connected to network

- For terminals used in standalone mode, it is strongly recommended to backup the local database regularly, and at least after significant changes in the database (add, remove or modification of user's records).

## Date / Time synchronization

- If you want to use the MorphoAccess® SIGMA Lite Series terminal for applications requiring high time precision, we recommend regularly synchronizing terminal time with an external clock.
- The MorphoAccess® SIGMA Lite Series terminal clock has a +/- 10 ppm typical time deviation at +25°C (roughly +/- 3sec per day).
- At lower and higher temperature, deviation may be greater (in worst case 7 seconds per day).

## Cleaning precautions

- A dry cloth should be used to clean the terminal, especially the biometric sensor.
- The use of acid liquids, alcohol or abrasive materials is prohibited.